

Datasheet

MIL-C-26482 II series connectors

Anovay Technologies Limited

MIL-C-26482 II series connectors

Brief Introduction
Contact Arrangements
Dust Cap

Specification
Product Outline Dimensions

Polarization
How To Order

■ Brief Introduction

1. According to the structure of MIL-C-26482 series II
2. quick bayonet coupling
3. removeable gold plated crimping contact
4. High contact density
5. RFI (radio frequency interference) shield plug
6. Mating surface sealing
7. widely used in military system and commercial fields

■ Specification

Ambient Temperature Range	-55℃ ~ +175℃ (W class)	-55℃ ~ +200℃ (L class, A class)
frequency	10~2000 Hz、1.0 G2/Hz	
Shock	300g m/s ²	
Salty spray	500 hours(W class); 96 hours(L class); 48 hours(A class)	
Durability	500 times	
relative humidity:	94 ± 4% at 65℃	
insulation resistance	≥5000M Ω at 25℃	≥500M Ω at 200℃

contact resistance and current rating:

contact size	operation diameter(mm)	contact resistance(m Ω)	current rating(A)
20#	Φ 1.0	≤5	7.5
16#	Φ 1.6	≤2.5	13
12#	Φ 2.4	≤1.5	23

operation voltage and withstanding voltage: V

operation level*	operation voltage		withstanding voltage	
	I	II	I	II
sea level	600	1000	1500	2300
21000m	300	450	375	500







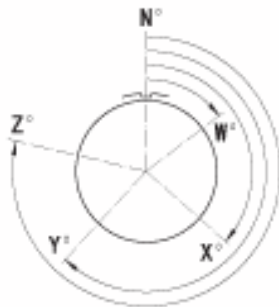



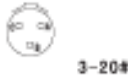













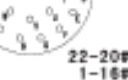

* Different insert arrangements have different operation classes. Please see the key polarization.

■ Polarization

shell size	insert code	operation		angle				
		level I	level II	N	W	X	Y	Z
08	08-98	✓		0	--	--	--	--
	08-33	✓		0	90	--	--	--
10	10-6	✓		0	90	--	--	--
12	12-10	✓		0	60	155	270	295
	12-8	✓		0	90	112	203	292
	12-3		✓	0	--	--	180	--
14	14-19	✓		0	30	165	315	--
	14-15	✓		0	17	110	155	234
	14-12	✓		0	43	90	--	--
	14-5		✓	0	40	92	184	273
	14-4	✓		0	45	--	--	--
16	16-26	✓		0	60	--	275	338
	16-23	✓		0	158	270	--	--
	16-8		✓	0	54	152	180	331
18	18-32	✓		0	85	138	222	265
	18-11		✓	0	62	119	241	340
	18-8	✓		0	180	--	--	--
20	20-41	✓		0	45	126	225	--
	20-39	✓		0	63	144	252	333
	20-16		✓	0	238	318	333	347
22	22-55	✓		0	30	142	226	314
	22-41	✓		0	39	135	264	--
	22-21		✓	0	16	135	175	349
	22-12	✓		0	--	--	--	--
	21-32	✓		0	72	145	215	288
22-95	✓		0	26	180	266	--	
24	24-61	✓		0	90	180	270	324
	24-31	✓		0	90	225	255	--
	24-19		✓	0	30	165	315	--



■ Contact Arrangements

shell size	33	98			
08	 3-20#	 3-20#			
10	 6-20#				
12	 10-20#	 3-16#	 8-20#		
14	 19-20#	 14-20# 1-16#	 8-20# 4-16#	 5-16#	 4-12#
16	 26-20#	 22-20# 1-16#	 8-16#		
18	 32-20#	 11-16#	 8-12#		
20	 41-20#	 37-20# 2-16#	 16-16#		
22	 55-20#	 27-20# 14-16#	 21-16#	 12-12#	 32-20#
				 26-20# 6-12#	
24	 61-20#	 31-16#	 19-12#		

[Product Outline Dimensions](#)

MS3475/MS3476

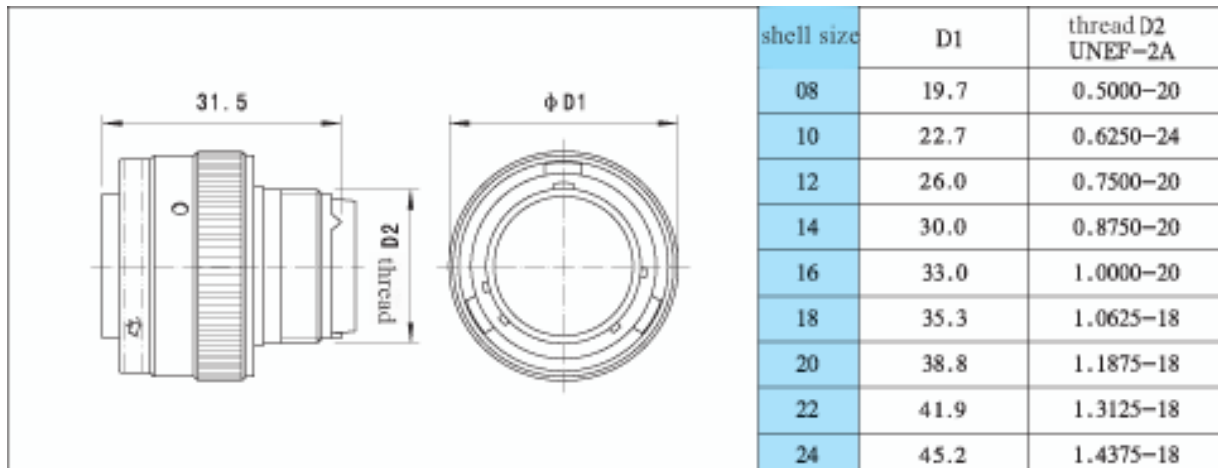

MS3474

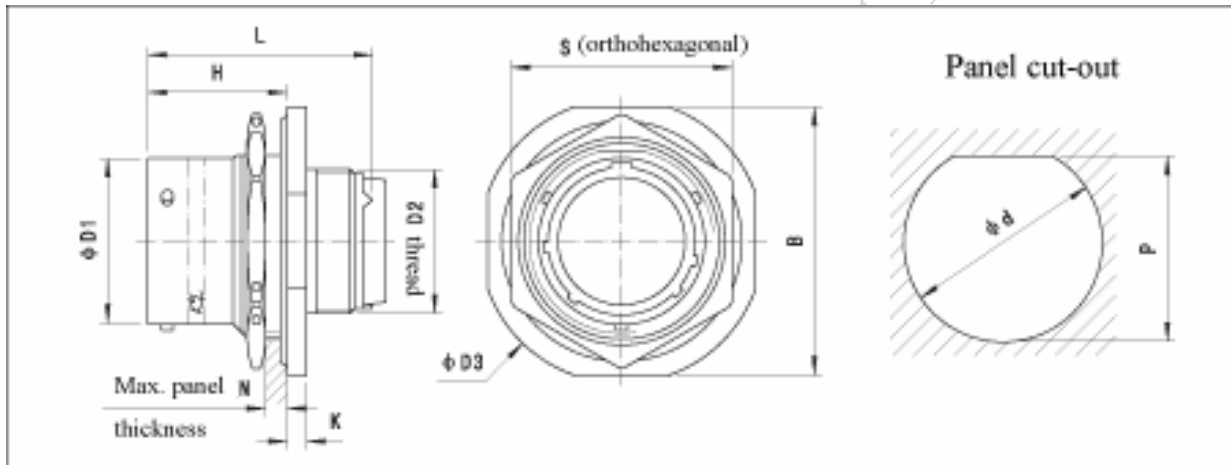

shell size	D1	thread D2 UNEF-2A	D3	L	H	K	B	S	N	d	P
08	12.0	0.5000-20	27.2	31.5	17.5	2.5	24.0	19.4	4.8	14.6	13.7
10	15.0	0.6250-24	30.4	31.5	17.5	2.5	27.0	22.6	4.8	17.8	16.9
12	19.1	0.7500-20	35.2	31.5	17.5	2.5	32.0	27.4	4.8	22.8	21.0
14	22.2	0.8750-20	38.3	31.5	17.5	2.5	35.0	30.2	4.8	25.7	24.1
16	25.4	1.0000-20	41.5	31.5	17.5	2.5	38.2	33.7	4.8	28.4	27.3
18	28.6	1.0625-18	44.7	31.5	17.5	2.5	41.5	36.9	4.8	32.1	30.5
20	31.8	1.1875-18	49.4	33.1	19.0	3.3	46.2	40.1	6.4	35.2	33.7
22	34.9	1.3125-18	52.6	33.1	19.0	3.3	49.4	43.3	6.4	38.4	36.8
24	38.1	1.4375-18	55.8	33.1	19.0	3.3	52.6	46.4	5.6	41.6	40.1

MS3470

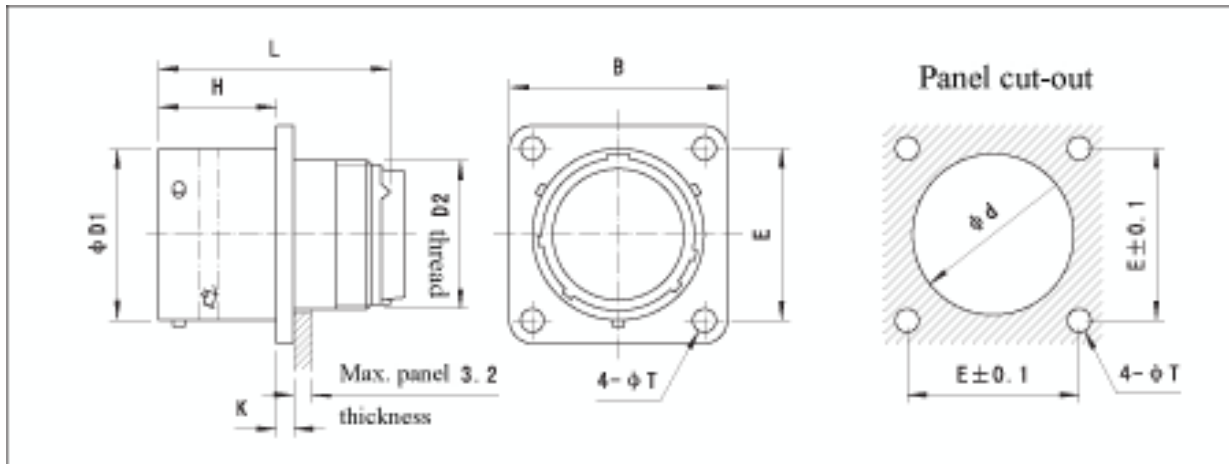

shell size	D1	thread D2 UNEF-2A	L	H	K	B	E	T	d
08	12.0	0.5000-20	31.5	11.7	1.8	21.0	15.1	3.2	14.4
10	15.0	0.6250-24	31.5	11.7	1.8	24.2	18.3	3.2	17.3
12	19.1	0.7500-20	31.5	11.7	1.8	26.5	20.6	3.2	21.9
14	22.2	0.8750-20	31.5	11.7	1.8	28.7	23.0	3.2	25.1
16	25.4	1.0000-20	31.5	11.7	1.8	31.2	24.6	3.2	28.2
18	28.6	1.0625-18	31.5	11.7	1.8	33.7	27.0	3.2	31.4
20	31.8	1.1875-18	33.1	14.3	2.7	36.9	29.4	3.2	34.6
22	34.9	1.3125-18	33.1	14.3	2.7	40.0	31.8	3.2	37.7
24	38.1	1.4375-18	33.1	15.2	2.7	43.3	34.9	3.7	41.0

Crimping contact

contact size	diameter mm	color ring of pin	color ring of socket	crimping boot ID mm	crimping boot OD mm	Wire section mm ²	AWG	outer insulating diameter of wire mm	Crimping tool/ locator P/N	extraction tool P/N
20 [#]	1.00	brown-brown-black	brown-brown-green	1.2	1.98	0.2 0.3 0.5	24 22 20	1.02~2.11	YJQ/XDWQ-01或 XCXY-01/DWQ-09	M81969/ 14-11
16 [#]	1.60	brown-brown-brown	brown-brown-blue	1.7	2.60	0.5 0.8 1.0 1.2	20 18 16	1.35~2.62	XCXY-01/DWQ-09	M81969/ 14-03
12 [#]	2.40	brown-brown-orange	brown-brown-gray	2.5	3.80	2.0 3.0	14 12	2.46~4.01	XCXY-01/DWQ-09	M81969/ 14-04

■ How To Order

MS 3474 L 14-4 P N

① ② ③ ④ ⑤ ⑥ ⑦

①: MS—Series Prefix

- ②: type: 3470 -narrow flange receptacle
3474 -jam nut receptacle
3475 - RFI plug ,3476 -plug
3476 -plug
- ③: shell plating:W - olive green cadmium plating
L - electroless nickel plating
A - anodic black coating
S – stainless steel passivation
B - green cadmium plating
- ④: Shell size :08-10-12-14-16-18-20-22-24
- ⑤: Insert arrangement: Please see the figure of insert arrangement
- ⑥: Contact :P-pin ,S-socket
- ⑦: Key: N- normal key; W、X、Y、Z- alternative key

■Dust cap

How To Order

MS	3180	-08	C	N
①	②	③	④	⑤

- ①: MS—Series Prefix
- ②: type:3180 –dust cap for plug
3181 –dust cap for receptacle
- ③: Shell size :08-10-12-14-16-18-20-22-24
- ④: Chain type:C-mental chain,
R-Nylon
N-mental chain with rings(for MS3474 receptacle)
- ⑤: shell plating:W - olive green cadmium plating
L - electroless nickel plating
A - anodic black coating
S – stainless steel passivation
B - green cadmium plating

Note: Dust cap is ordered separately, which is not provided with connector.

Dimension (MS3180/MS3181)

dust cap for plug
MS3180-

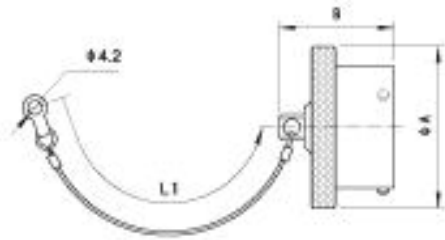

dust cap for receptacle
MS3181-

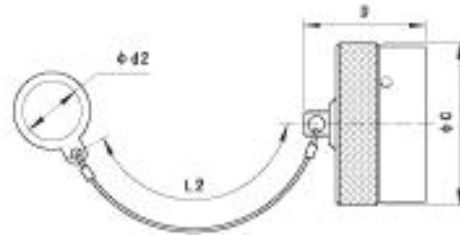
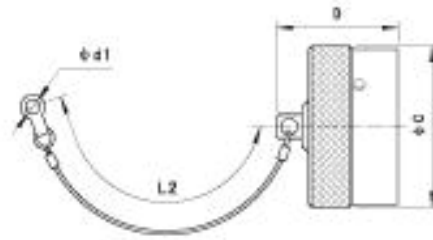

shell size		08	10	12	14	16	18	20	22	24
A	MAX	18.2	21.4	23.4	25.3	31.7	34.9	38.1	41.2	44.4
B	MAX	18.5	18.5	18.5	18.5	18.5	18.5	20.0	20.0	20.0
C	MAX	19.1	22.3	23.9	25.0	32.2	35.4	38.6	41.7	44.9
D	MAX	21.4	21.4	21.4	21.4	21.4	21.4	21.4	21.4	22.2
d1	MIN	3.2	3.2	3.2	3.2	3.2	3.2	3.2	3.2	3.2
d2	MIN	14.7	17.9	22.7	25.9	29.0	32.2	35.4	38.6	41.7
L1	MAX	76.2	76.2	88.9	88.9	88.9	88.9	104.6	101.6	101.6
L2	MAX	76.2	76.2	88.9	88.9	88.9	88.9	104.6	101.6	101.6